

IL **FEC**, partner della Regione Lazio del Bando “Torno Subito” edizione 2015, presenta i progetti “**La storia senza barriere**” e “**Borgo Nostrum**” dei due architetti vincitori, rispettivamente l’Arch. **Francesca Bozza** e l’Arch. **Francesco Spagnoli**

DESIGN PROJECT  
SULLA SOSTENIBILITA’  
PER LA SABINA, PROVINCIA DI RIETI

“**Borgo Nostrum**”

SOSTENIBILITA’  
AMBIENTALE

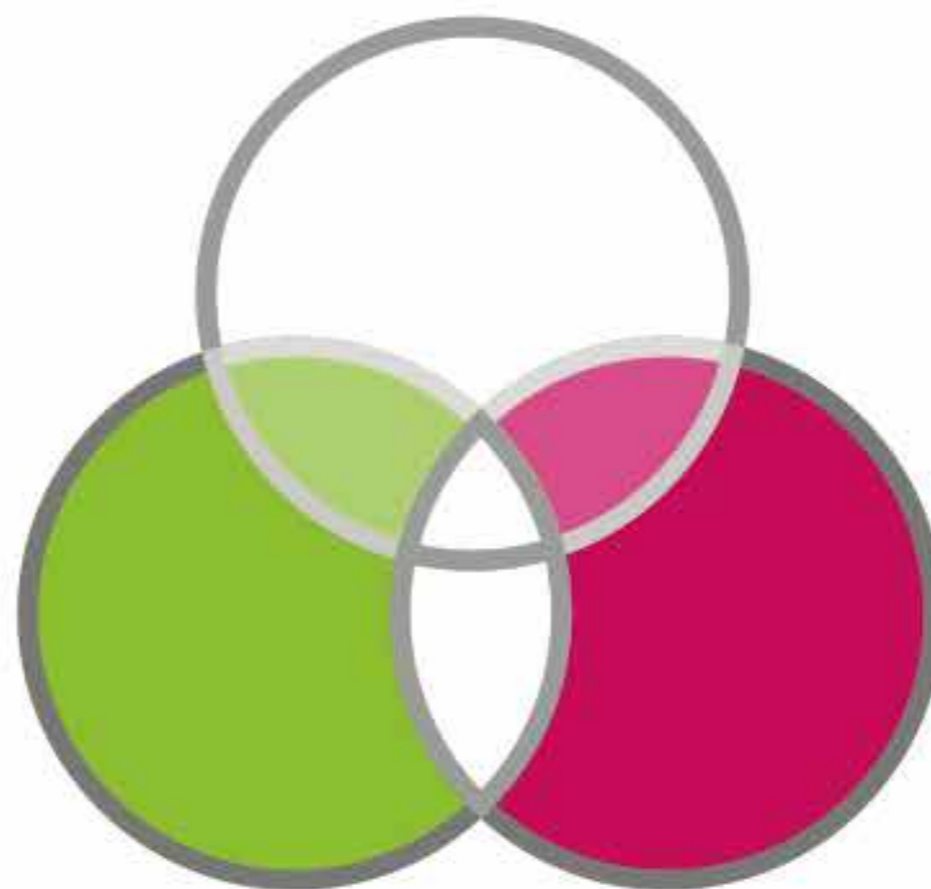

“**La storia senza barriere**”

SOSTENIBILITA’  
SOCIALE



IL materiale raccolto è stato prodotto dagli architetti Bozza e Spagnoli presso il Partner fuori Regione, lo studio di Architettura “*aNNo Architecten*” in Belgio, e presso il FEC, all’interno dell’U.T.G., la **Prefettura di Rieti**.



REGIONE LAZIO



SABINA



PROVINCIA DI RIETI

# Itineraries PLAN

## UMBRIA REGION

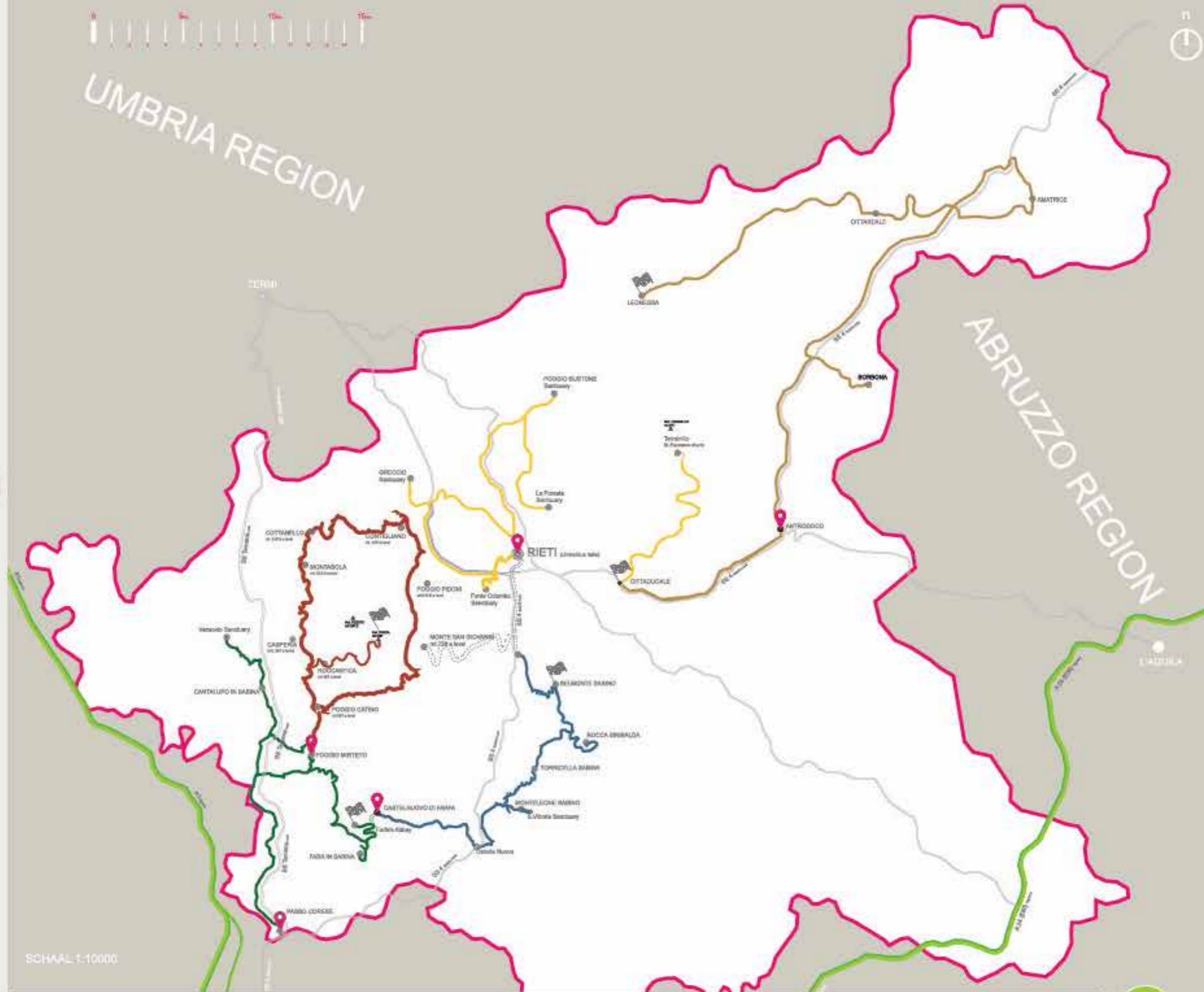

SCHAAL 1:10000

LA STORIA SENZA BARRIERE & BORGO NOSTRUM  
Progetti vincitori del Bando Torno Subito 2015

Arch.Francesca Bozza e Arch.Francesco Spagnoli

SOSTENIBILITA'  
AMBIENTALE E  
SOCIALE



# ANALISI AMBIENTALE SABINA

## LEGEND KEY SIGNS

### WATER SYSTEM (HYDROGEOLOGICAL)

Secondary rivers

Main rivers

Lakes

### MOUNTAINS SYSTEM

High mountains

Low mountains

Hills

### NATURAL POINTS

Mountain (TOP)

Mountain Region

Panoramic view

REATINI

REATINI

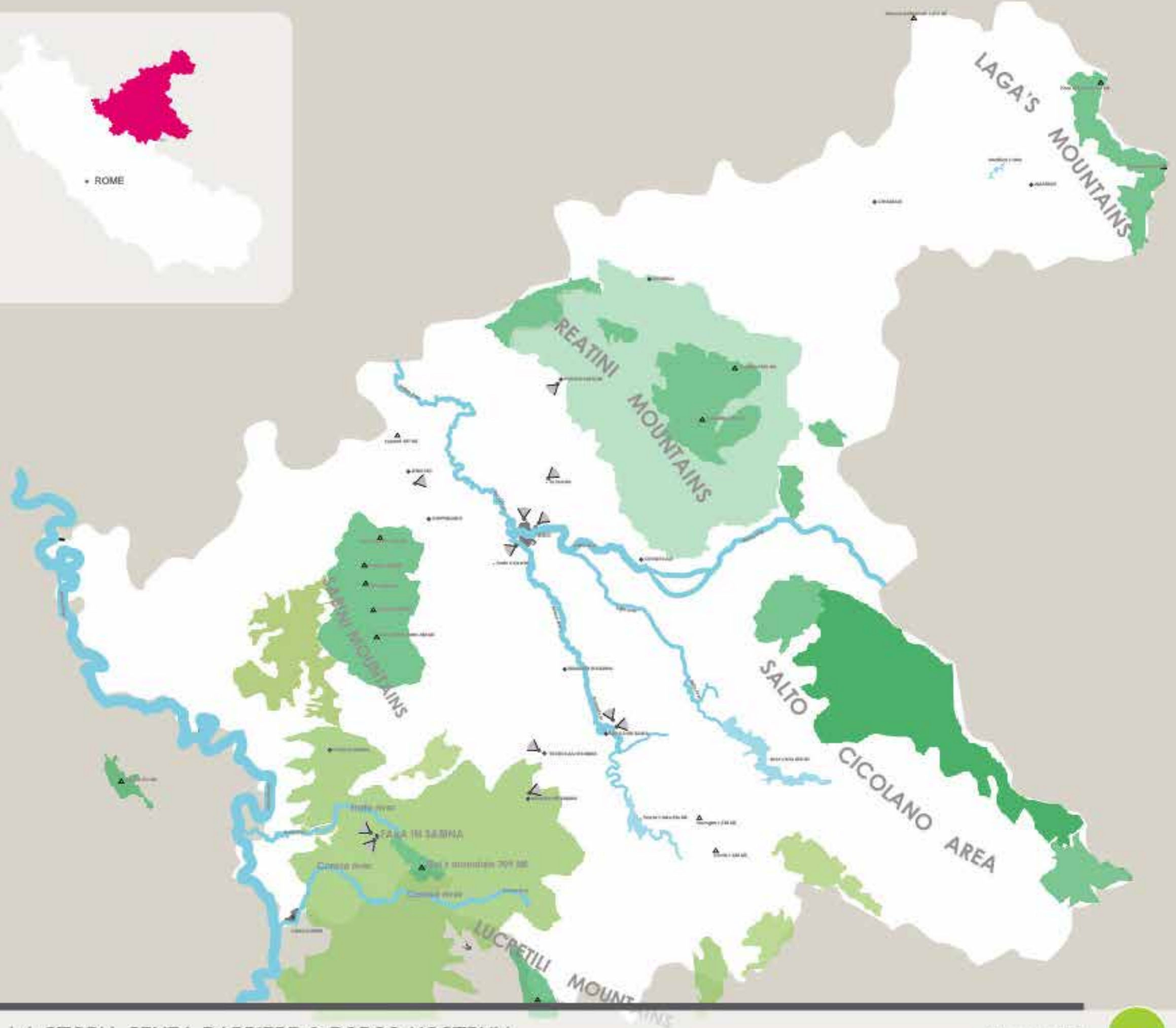

LA STORIA SENZA BARRIERE & BORGO NOSTRUM  
Progetti vincitori del Bando Torno Subito 2015.

Arch.Francesca Bozza e Arch.Francesco Spagnoli

SOSTENIBILITÀ  
AMBIENTALE E  
SOCIALE



I valori connessi a luoghi ed edifici di culto

Legenda

	Archeological site
	Convent
	Castle
	Citadel Fortress
	Sanctuary
	Church
	Abbey
	political/military influence
	roman influence

historical value	
environmental value	
spiritual value	
materials value	
structural value	
artworks	

1	FARA IN SABINA - Farfa Abbey	
2	MONTESCOLE SABINO - S. Vitale's Church, Archaeological site	
3	TORRICELLA IN SABINA (Chiesa S. Maria della Grazie)	
4	ROCCA SINBALDA - Biancolione Castle	
5	RIETI - City, Churches, (S. Francesco, La Focella's Sanctuary)	
6	CONSOLEANO - Fontecostanzo Sanctuary	
7	GRECCIO - Sanctuary	
8	POGGIO BUONFIORE - Sanctuary	
9	SCANDOROLA PONTERELLI - Sanctuary (PEC)	

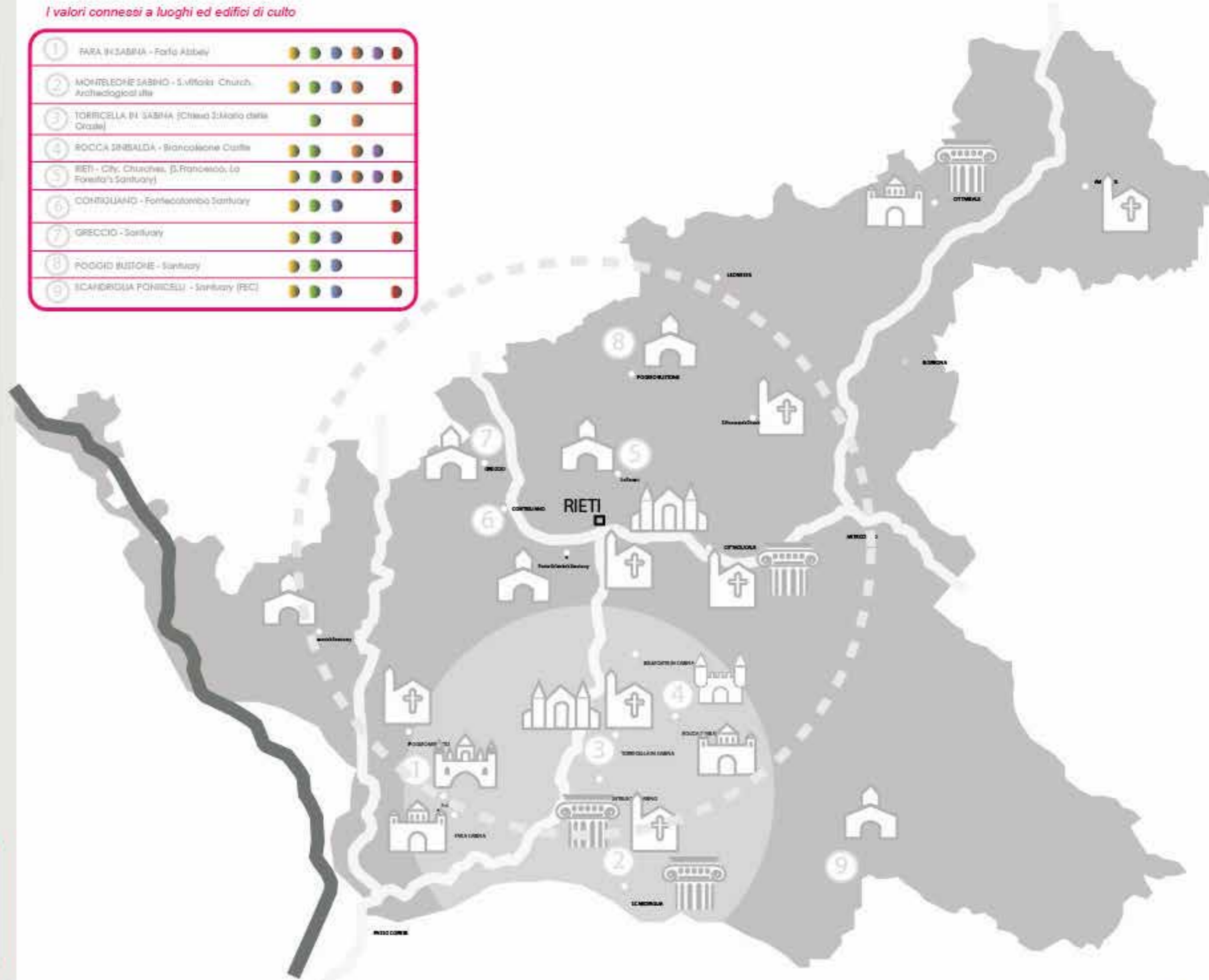

Study of the value of the main places; —>  
 The aim is: Increase the value, depending on the different aspects.  
 Intangible value:  
 (historical value, spiritual value, materials value, structure/architectural style value.)

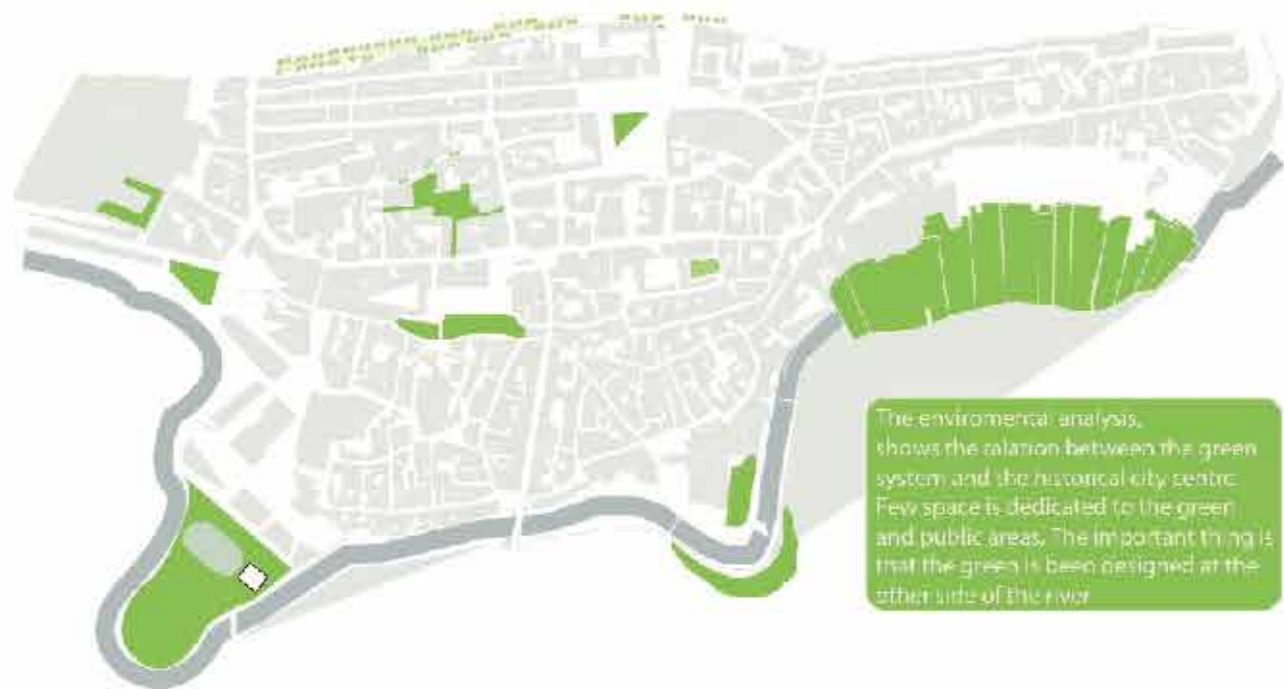

Analisi delle principali aree verdi del centro storico di Rieti

I parcheggi principali del centro storico di Rieti

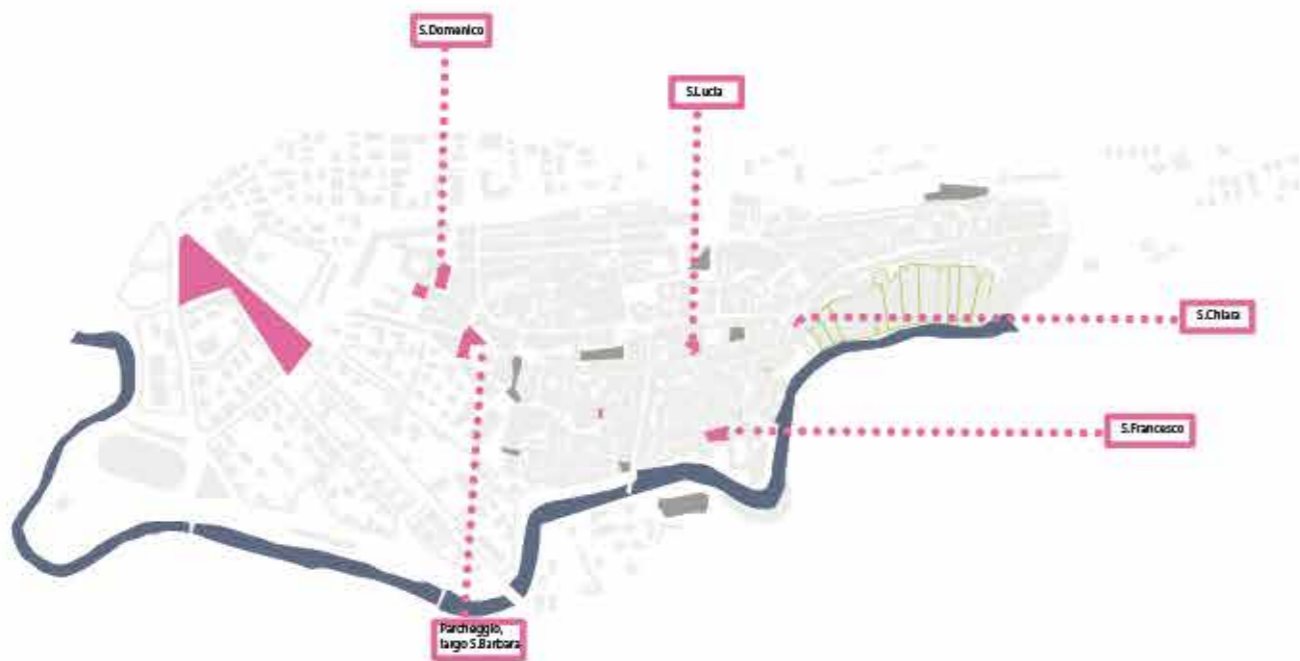

I luoghi di culto del centro storico di Rieti

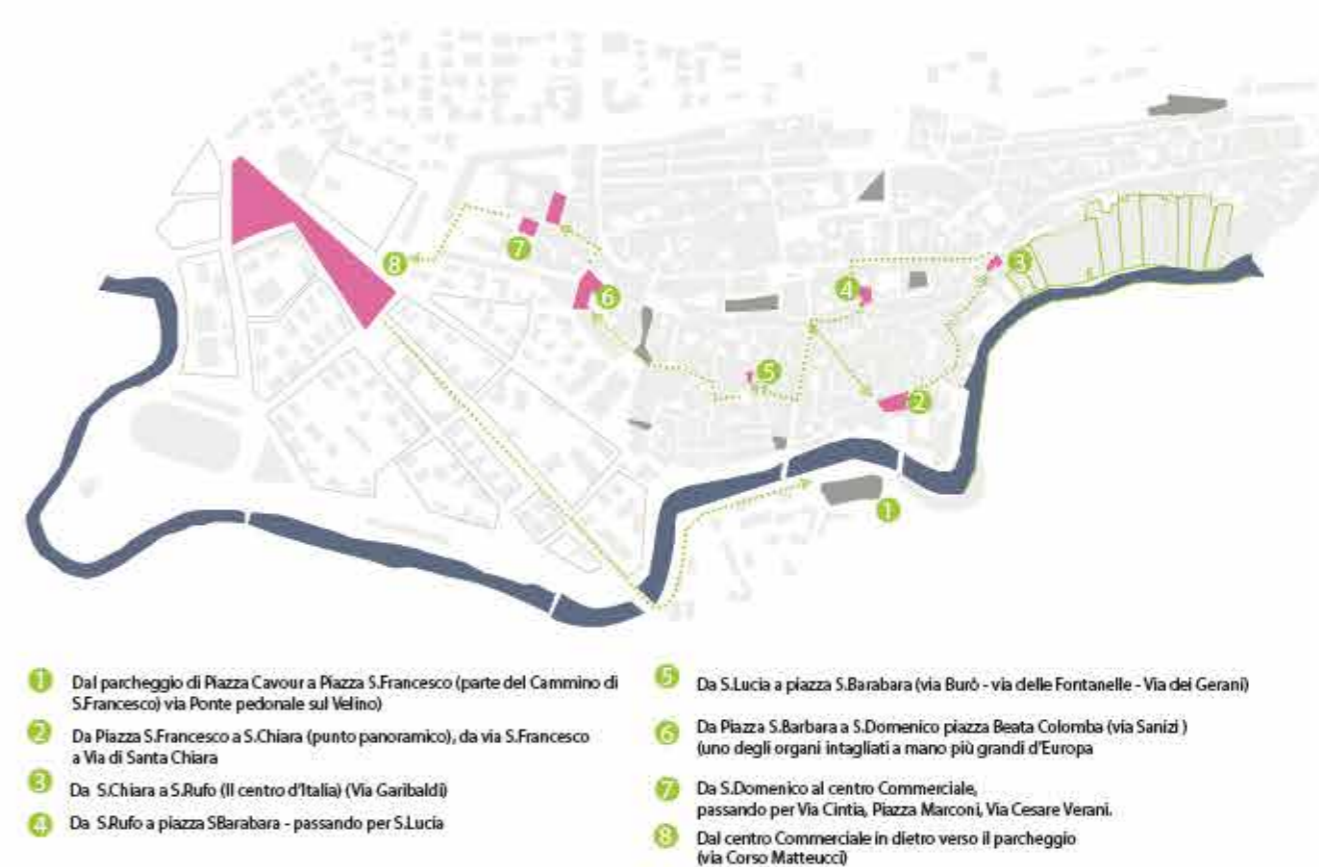

- 1 Dal parcheggio di Piazza Cavour a Piazza S. Francesco (parte del Cammino di S. Francesco) via Ponte pedonale sul Velino)
- 2 Da Piazza S. Francesco a S. Chiara (punto panoramico), da via S. Francesco a Via di Santa Chiara
- 3 Da S. Chiara a S. Rufo (Il centro d'Italia) (Via Garibaldi)
- 4 Da S. Rufo a piazza S. Barbara - passando per S. Lucia
- 5 Da S. Lucia a piazza S. Barbara (via Burò - via delle Fontanelle - Via del Gerani)
- 6 Da Piazza S. Barbara a S. Domenico piazza Beata Colomba (via Sanizi) (uno degli organi intagliati a mano più grandi d'Europa)
- 7 Da S. Domenico al centro Commerciale, passando per Via Cintia, Piazza Marconi, Via Cesare Verani.
- 8 Dal centro Commerciale in dietro verso il parcheggio (via Corso Matteucci)

Analisi schematiche, siti di interesse storico e punti di aggregazione

Planimetrie schematizzate dello stralcio centro storico della città di Rieti

LA STORIA SENZA BARRIERE & BORGO NOSTRUM  
Progetti vincitori del Bando Torno Subito 2015  
Arch. Francesca Bozza e Arch. Francesco Spagnoli

SOSTENIBILITÀ  
AMBIENTALE E  
SOCIALE





*Gli interni, navata, cappelle laterali e cupola.*



*L'esterno della chiesa e la piazza antistante.*



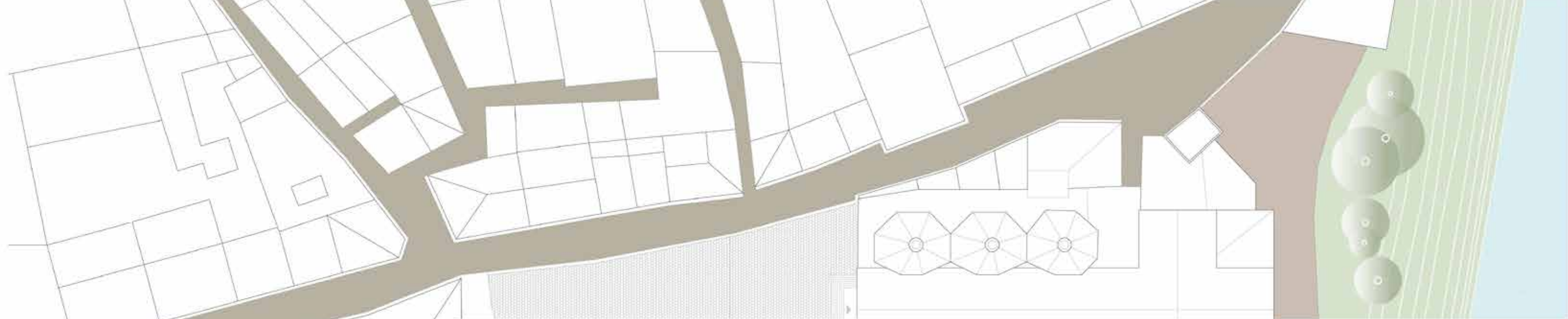

RILIEVO DELLA PIAZZA DI S.FRANCESCO, RIETI - Sezione longitudinale

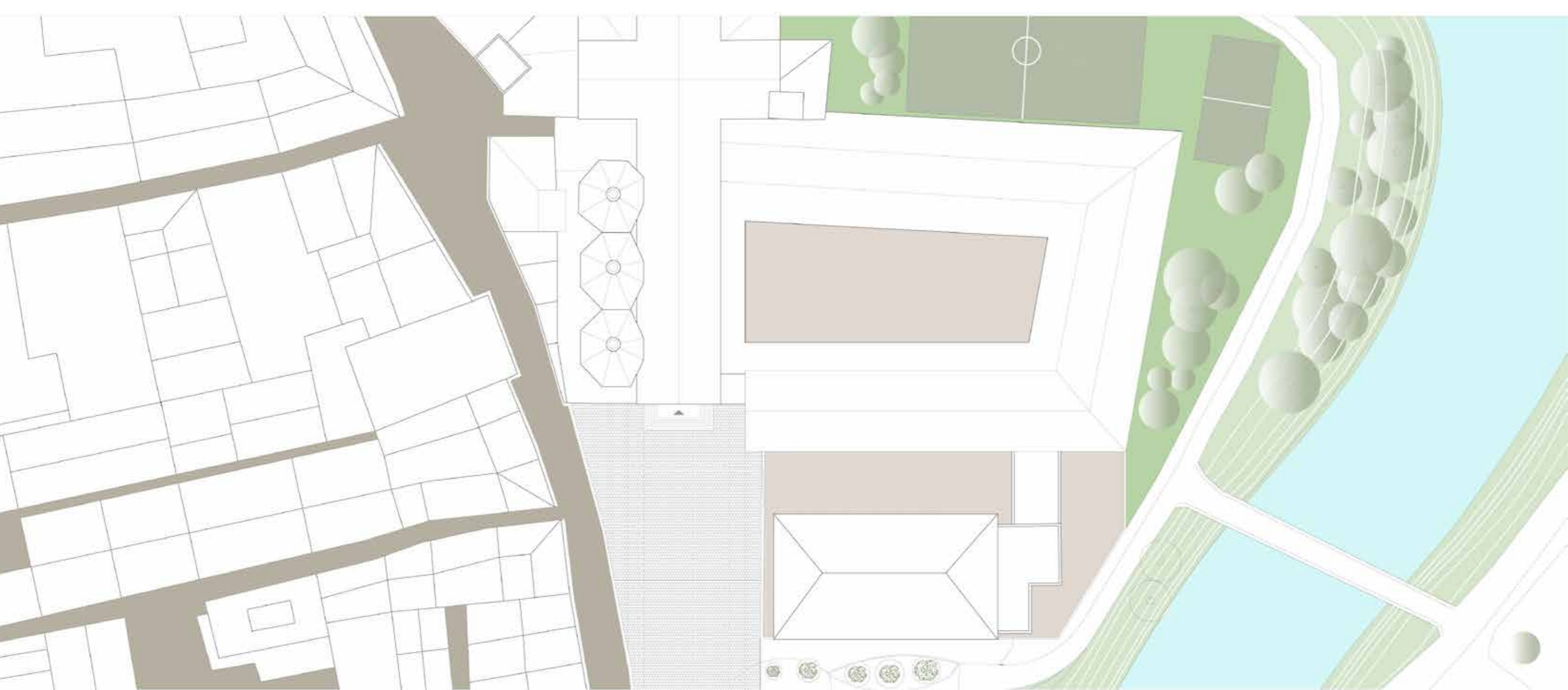

RILIEVO DELLA PIAZZA DI S.FRANCESCO, RIETI - Sezione trasversale





## Stratificazione storica

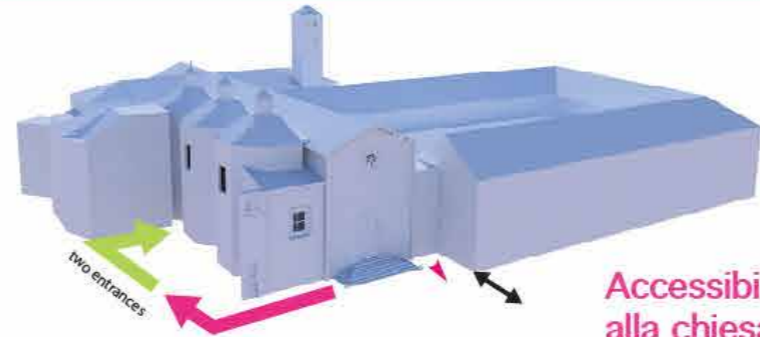
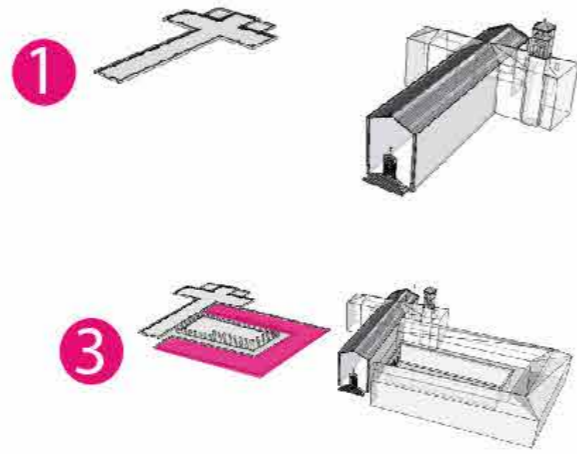

- Accessibilità alla chiesa**
- new accessible entrance (directs to the chapel hall)
  - original entrance (main entrance to the church)
  - emergency exit from the courtyard of the school (old convent)
  - ↔ ordinary entrance for students, space to leave free for emergency (ambulance entrance)

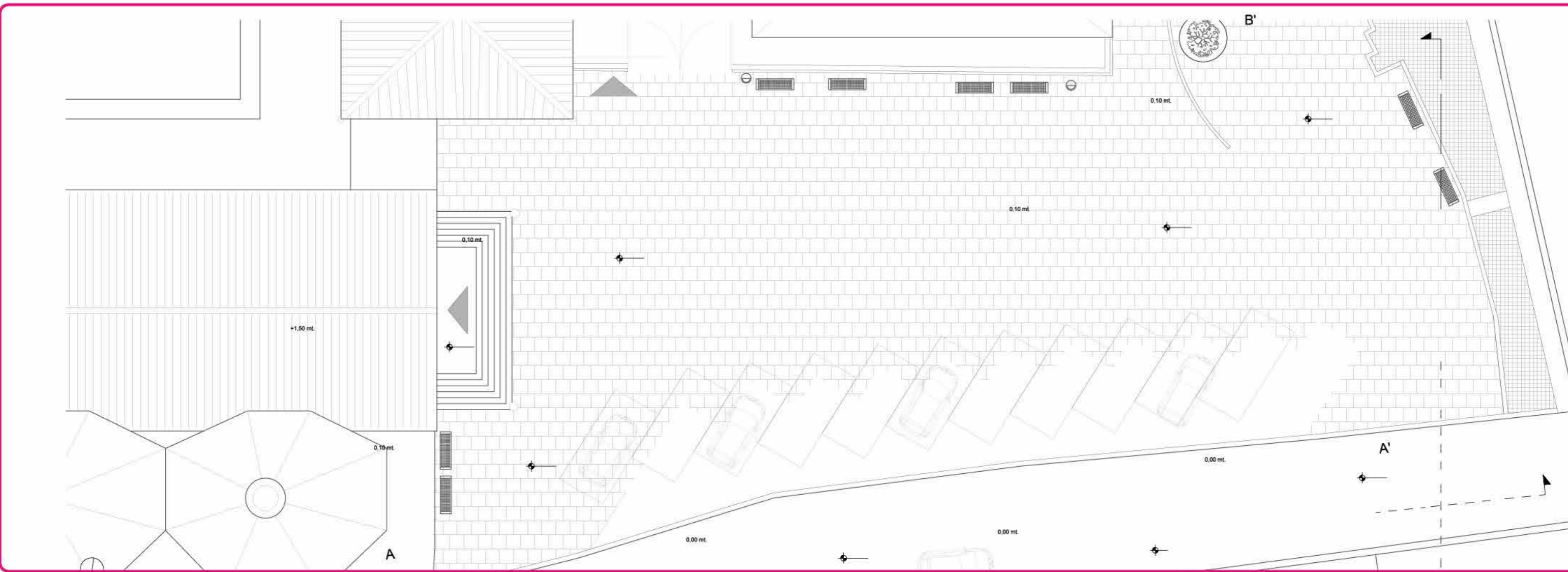
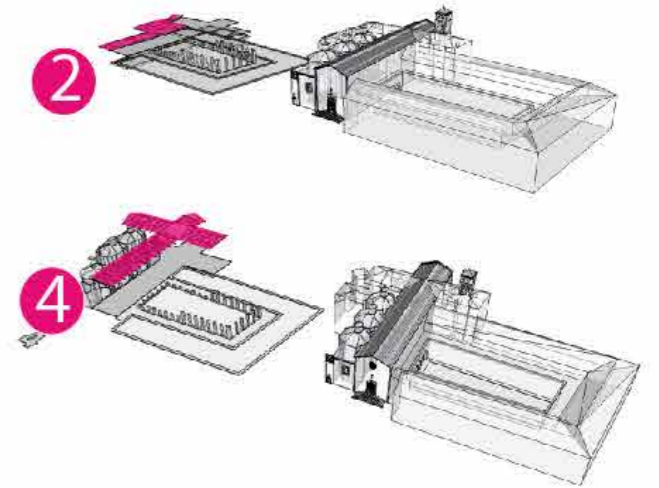

## Dettaglio della sistemazione della Piazza di S. Francesco

Stato attuale dell'arredo urbano e della disposizione dei parcheggi

LA STORIA SENZA BARRIERE & BORGO NOSTRUM  
 Progetti vincitori del Bando Tomo Subito 2015  
 Arch.Francesca Bozza e Arch.Francesco Spagnoli



# CAPPELLA INFERIORE S.FRANCESCO



Fotografie degli interni della Capella inferiore di S:Francesco



LA STORIA SENZA BARRIERE & BORGO NOSTRUM  
Arch.Francesca Bozza e Arch.Francesco Spagnoli

SOSTENIBILITA'  
AMBIENTALE E  
SOCIALE



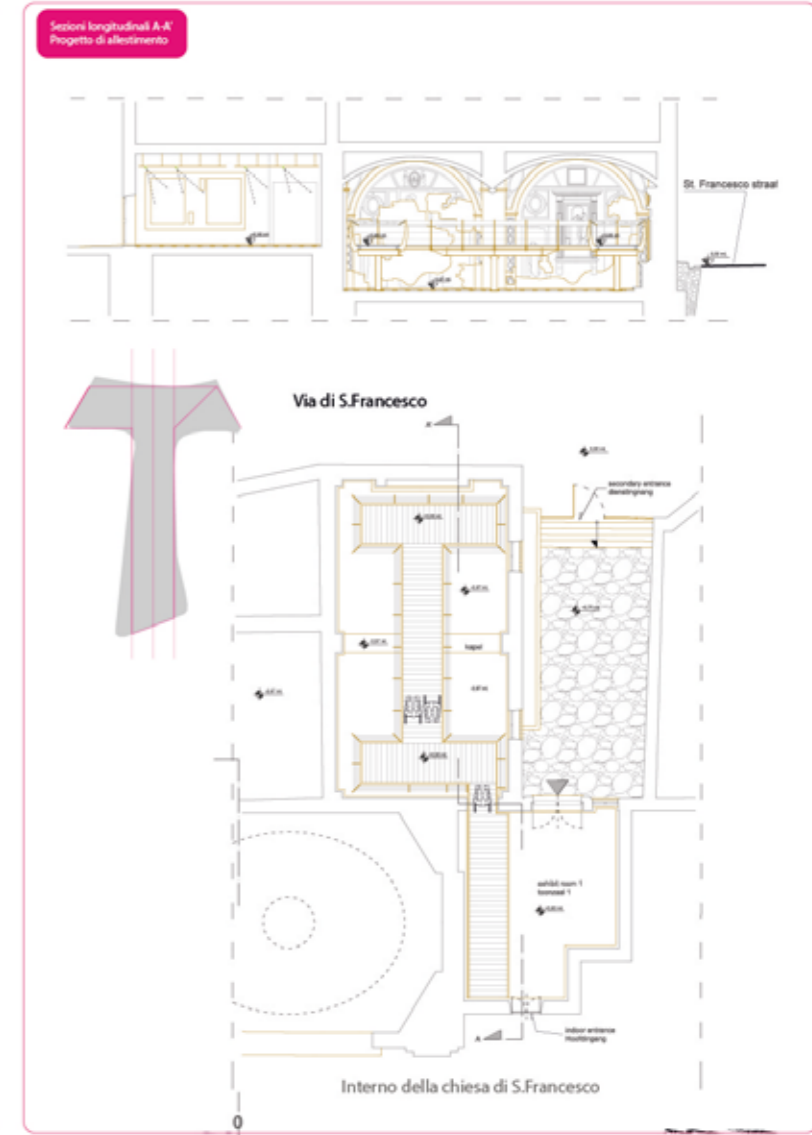
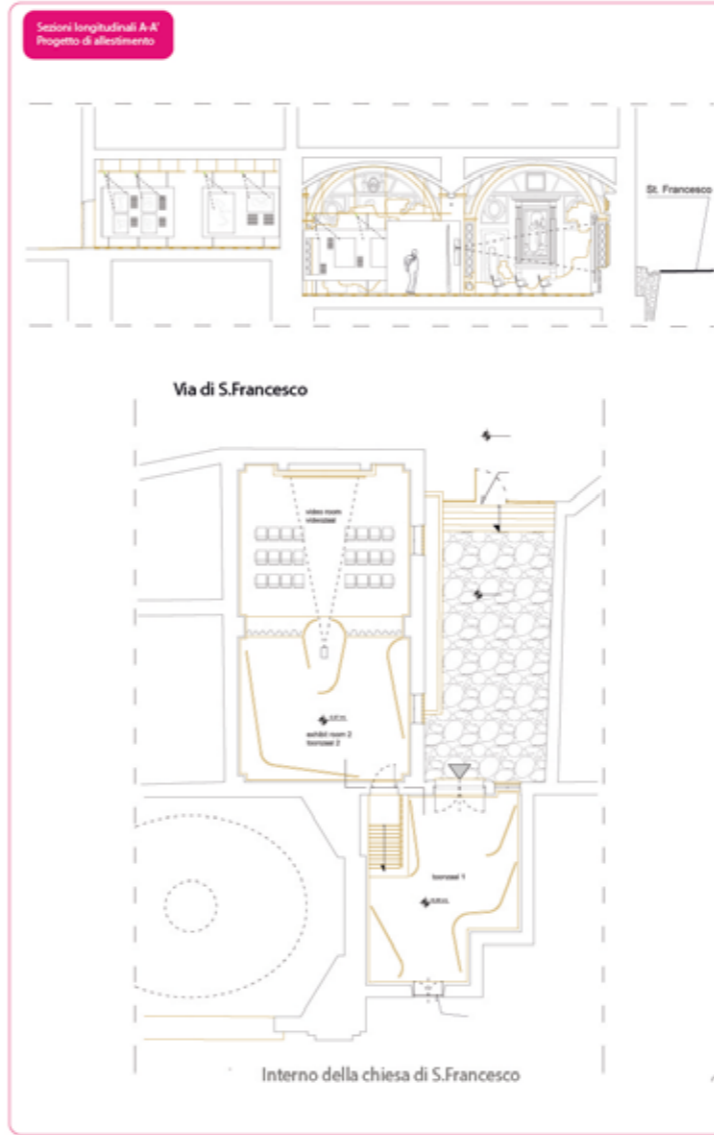
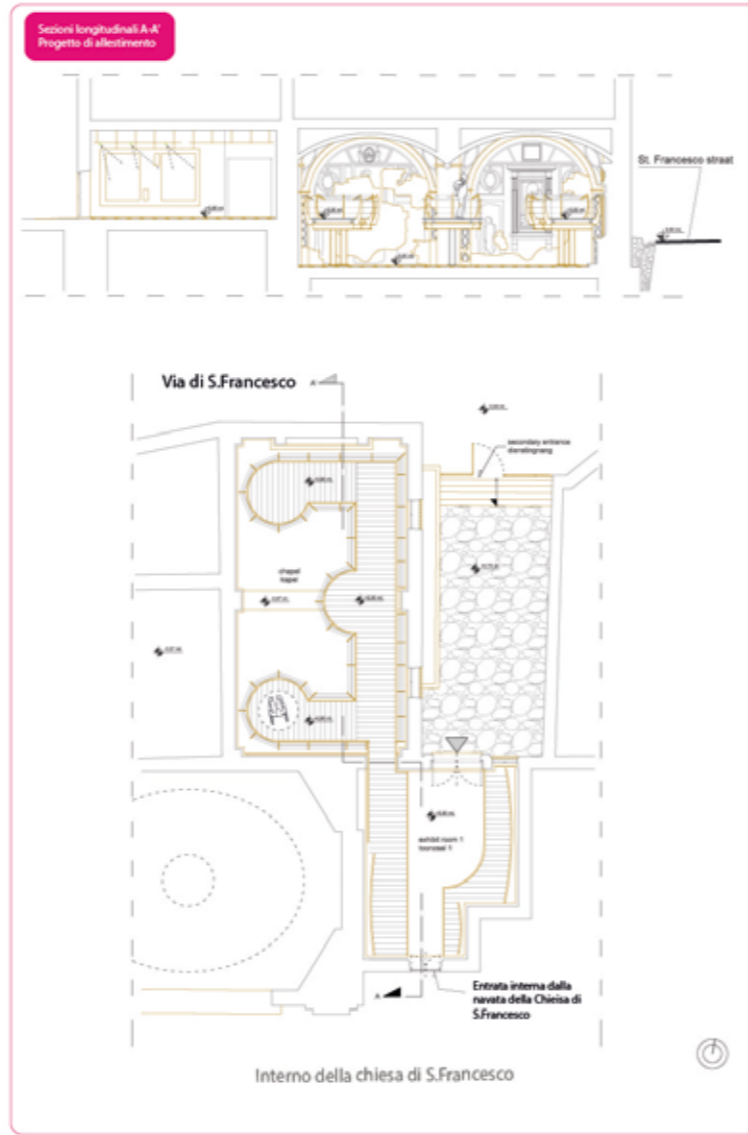
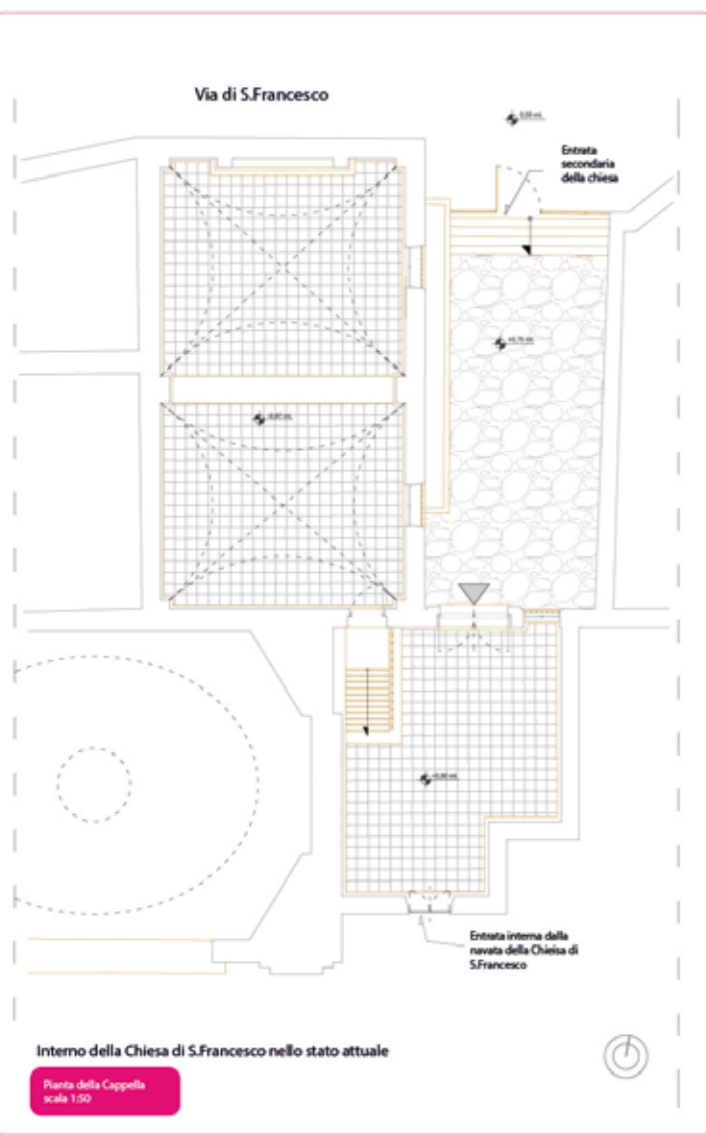

Dettagli della pianta della Chiesa di S. Francesco piano 0 e -1 entrata secondaria accessibile

**Piante scala 1:100 della cappella**  
Stato attuale e ipotesi di allestimenti per mostre e proiezioni.

Arch. Francesca Bozza e Arch. Francesco Spagnoli

LA STORIA SENZA BARRIERE & BORGO NOSTRUM  
Progetti vincitori del Bando Torno Subito 2015



**DETTAGLI**

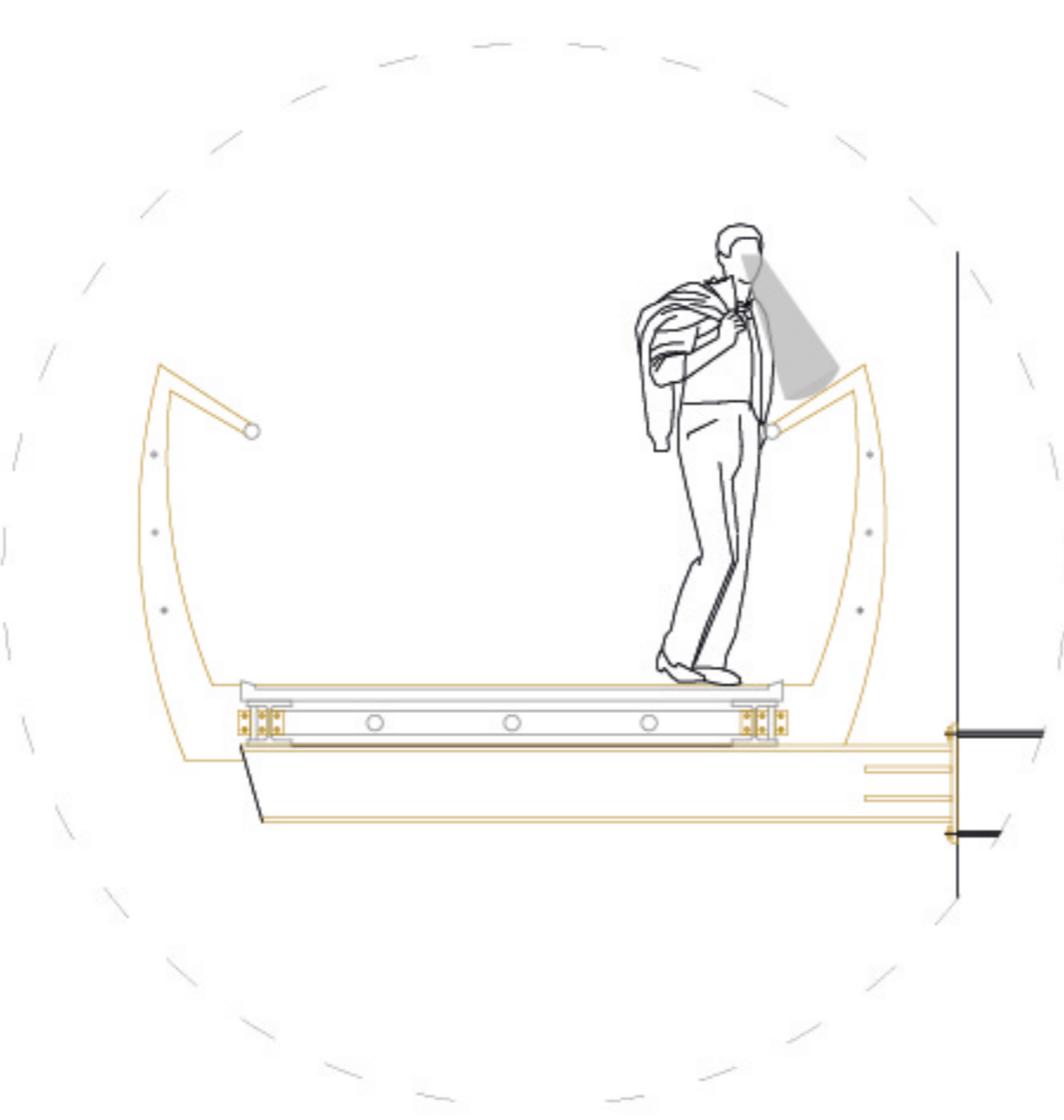

Idea progettuale per la fruizione degli affreschi e degli stucchi della volta della Cappella; al tempo stesso questa soluzione per permettere a tutti gli utenti una visita nella Cappella, attualmente situata ad un livello inferiore rispetto all'interno della Chiesa di S. Francesco

**Ipotesi della passerella**  
Pannelli integrati alla struttura accessibili in linguaggi Braille, WLS e PCS

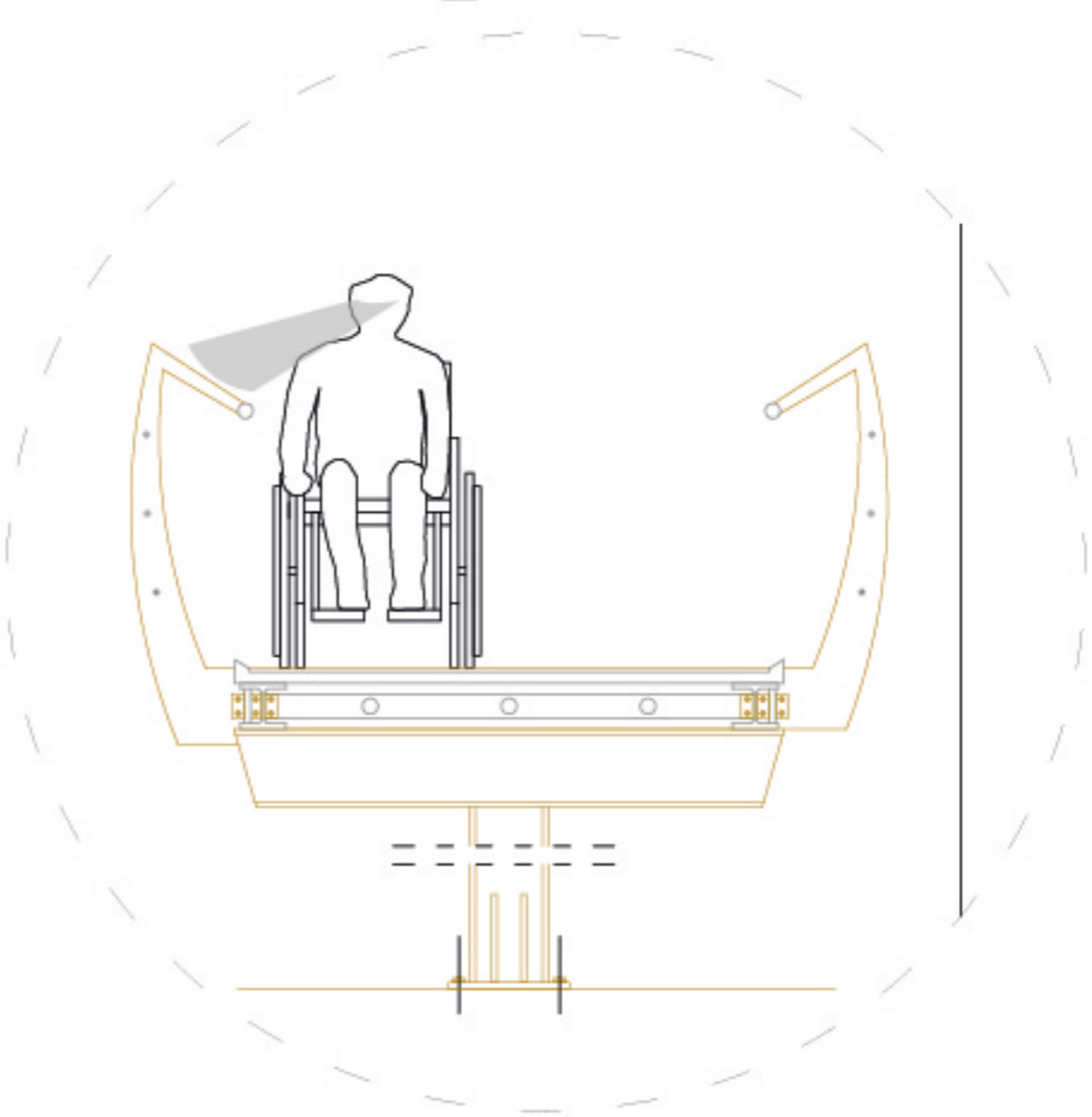



Piazza S.Rufo, "Il centro di'Italia", Rieti

LA STORIA SENZA BARRIERE & BORGO NOSTRUM  
Progetti vincitori del Bando Torno Subito 2015  
Arch.Francesca Bozza e Arch.Francesco Spagnoli



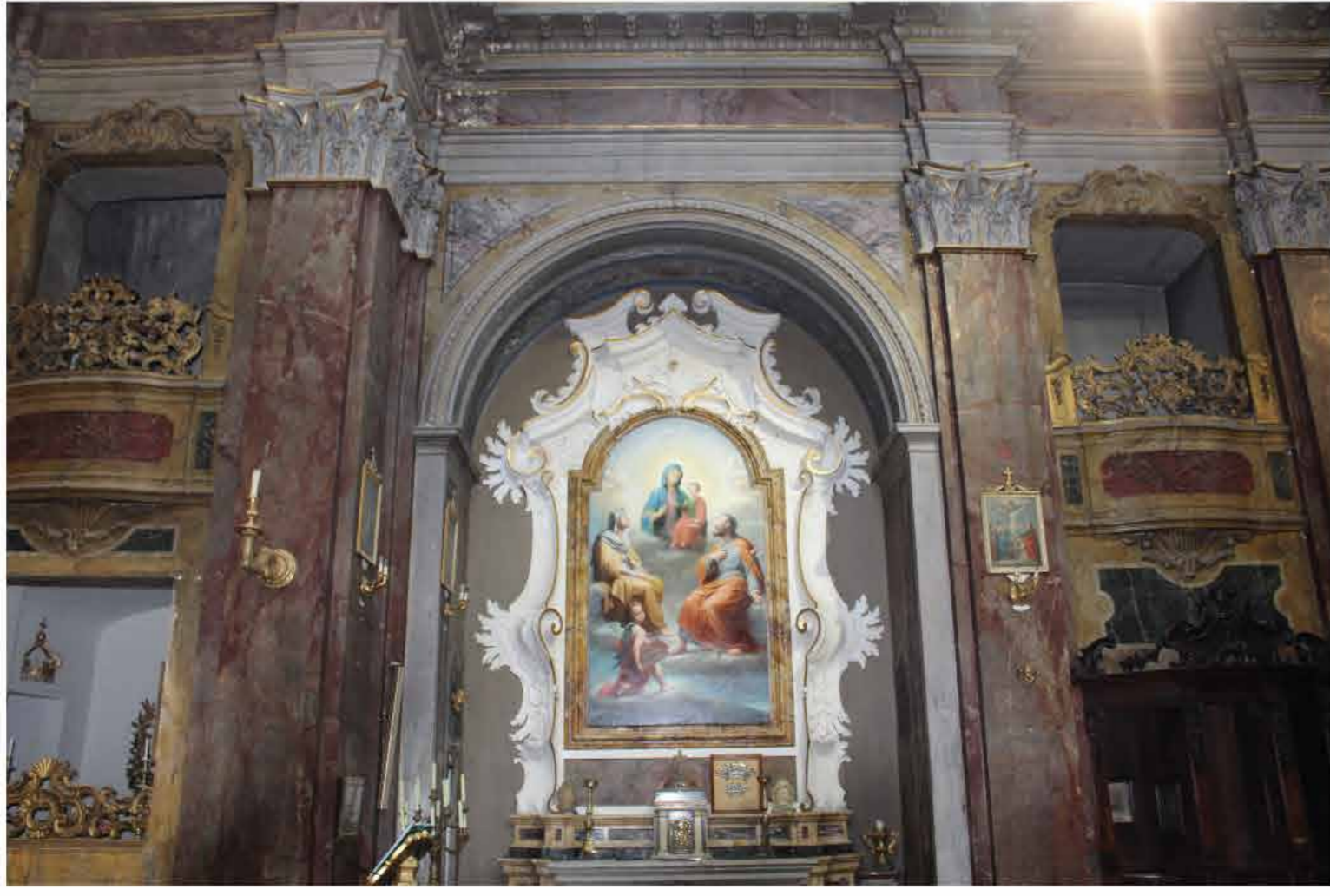
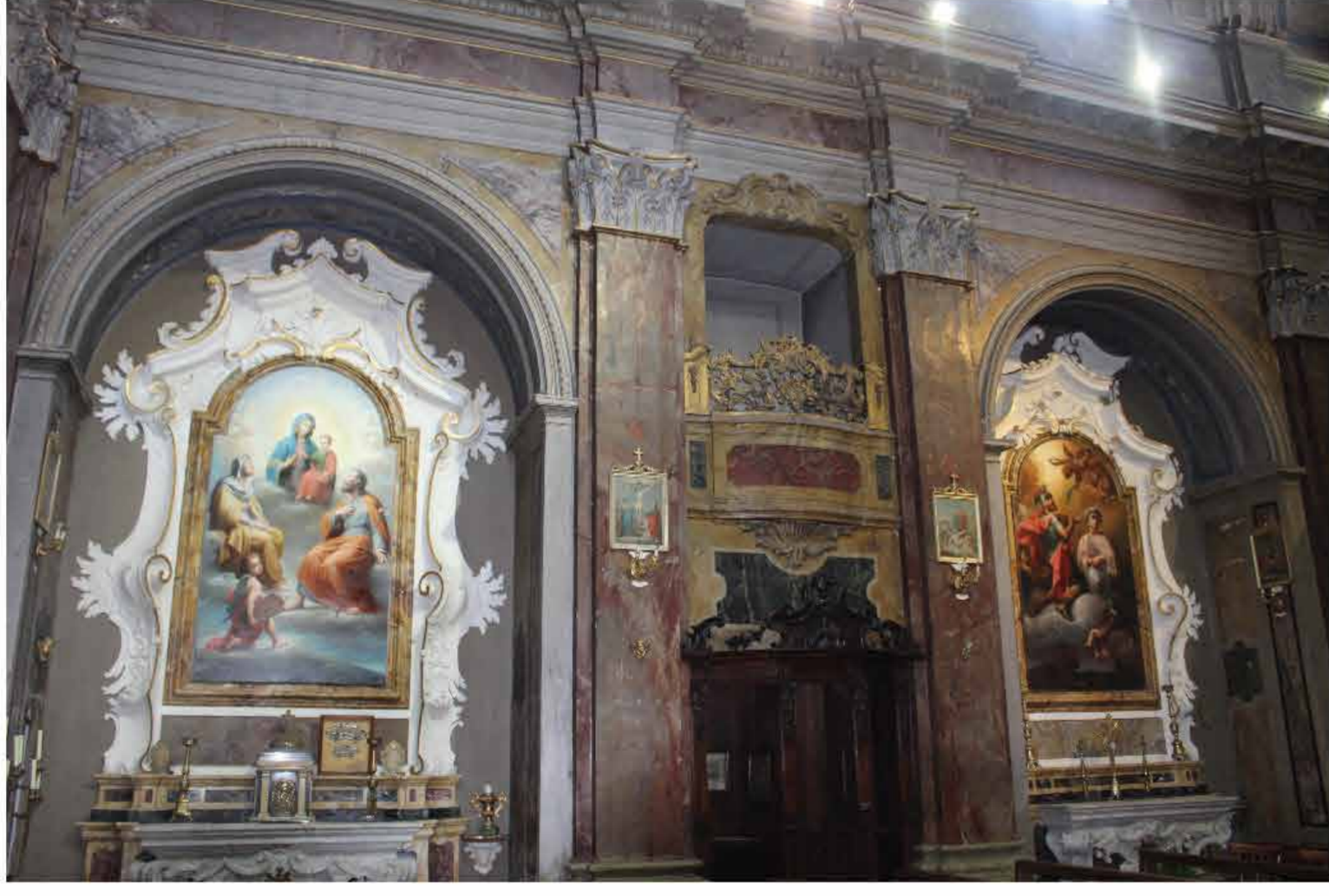
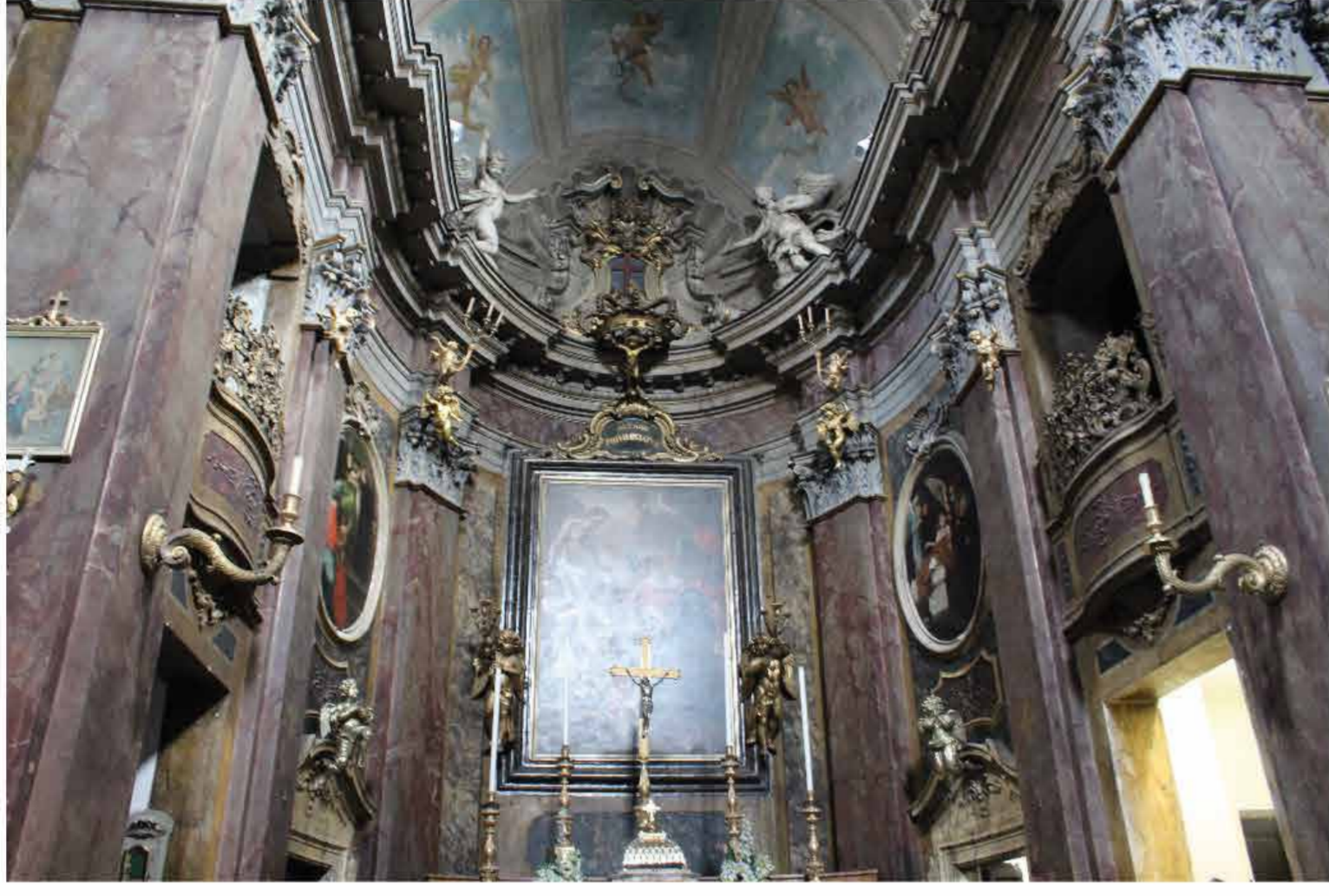
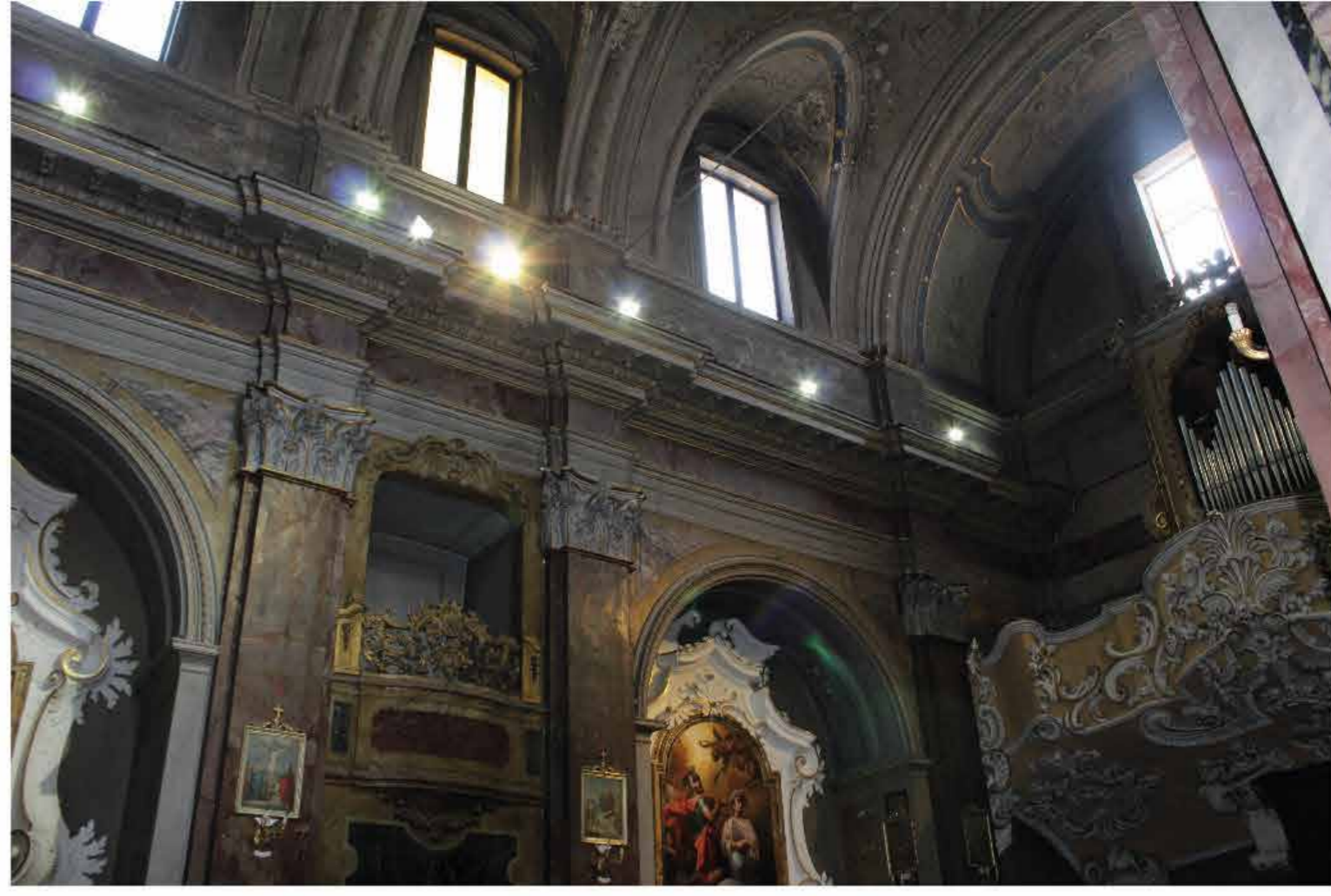

Raccolta di materiale fotografico, visuali interne della Chiesa di S.Rufo



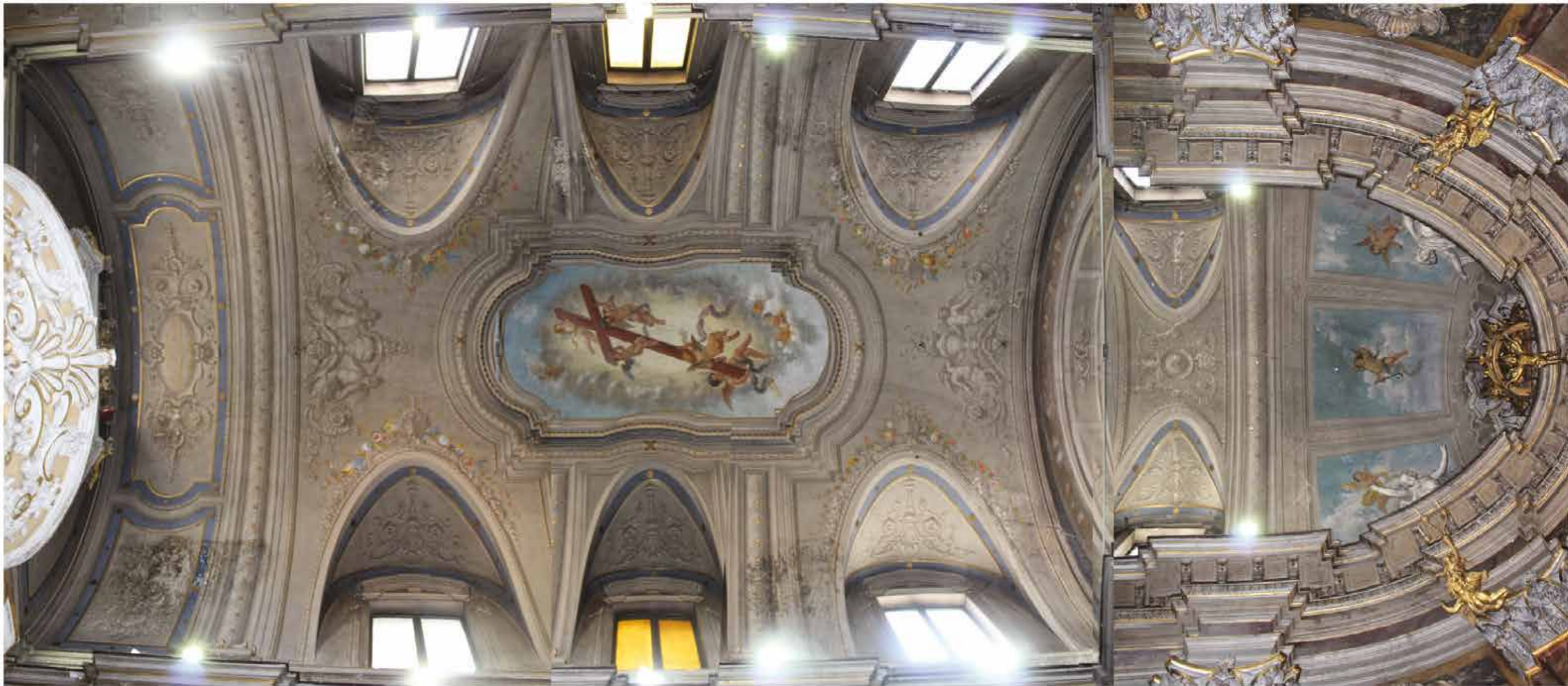

*Quadro di unione del rilievo fotografico della volta della*  
**Chiesa di S.Rufo**

LA STORIA SENZA BARRIERE & BORGO NOSTRUM  
Progetti vincitori del Bando Torno Subito 2015  
Arch.Francesca Bozza e Arch.Francesco Spagnoli





Piazza S.Rufo, "Il centro di'Italia", Rieti

LA STORIA SENZA BARRIERE & BORGO NOSTRUM  
Progetti vincitori del Bando Torno Subito 2015  
Arch.Francesca Bozza e Arch.Francesco Spagnoli

